

# Buderus SB625WS/160 Stainless Steel Condensing Boiler

Engineering  
Submittal  
Sheet



# BOSCH

## Boiler Components

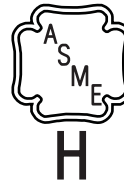
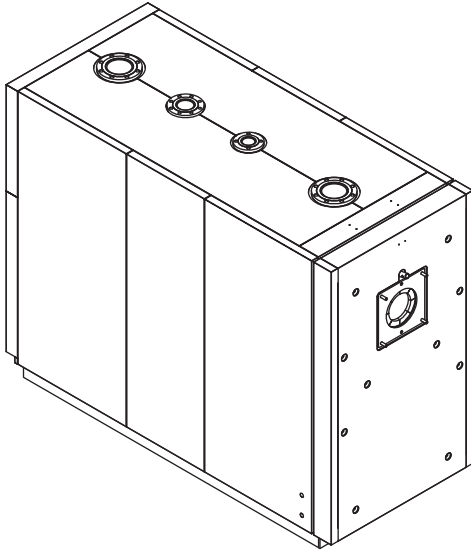

## Engineering Specifications

The boiler(s) shall have a full three pass fire tube design to allow complete combustion of the fuel in the main combustion chamber. All flue side surfaces, including the main combustion chamber, second and third flue passages shall be constructed of 316Ti stainless steel designed to maximize condensate formation. All flue passages shall be fully water-backed to minimize thermal stresses on the boiler vessel.

Boiler(s) shall be constructed with dual return water connections where the lower connection shall be aligned with the lowest (coldest) return water temperature for maximum efficiency.

Boiler(s) shall be suitable to operate under any return water temperature, boiler water flow rate and without any restrictions on temperature rise through the boiler vessel. Boiler(s) shall be

able to operate at efficiencies up to 98% at suitably low return water temperatures.

The tertiary fire tube flue passages shall be fabricated from 316Ti stainless steel with turbulators to maintain a near constant velocity of combustion products and to enhance turbulence at the boundary layer for maximum heat transfer.

Boiler(s) shall have an internal water baffle plate separating return water between second and third flue passages for maximum efficiency.

Boiler(s) shall be fully serviceable from the front by means of a reversible swing burner door.

# Buderus SB625WS/160 Stainless Steel Condensing Boiler



# BOSCH

Performance Data		
	Unit	Value
Gas input	MBtu/h [kW]	563 [164.9]
Oil input	GPH	N/A
Gross rated output	MBtu/h [kW]	532 [155.9]
Gross output @ 104 °F supply / 86 °F return (40 °C / 30 °C)	MBtu/h [kW]	544 [159.7]
Gross output @ 176 °F supply / 140 °F return (80 °C / 60 °C)	MBtu/h [kW]	504 [147.8]
IBR Net Rating	MBtu/h [kW]	463 [135.7]
Boiler horsepower	H.P	16.3
AHRI Natural gas combustion efficiency	%	95.0
AHRI Natural gas thermal efficiency	%	94.6

General Data		
	Unit	Value
Boiler category	-	Condensing
Heat exchanger construction	-	Stainless steel
Heating surface	Sq. Ft [m2]	65.65 [6.1]
Maximum allowable working pressure	PSIG [bar]	80 [5.5]
Water content	Gallons [Liters]	85.3 [323]
Weight - dry	Lbs [kg]	1232 [559]
Weight - shipping (approx.)	Lbs [kg]	1350 [612]
Venting category	-	II, IV

Operational Data		
	Unit	Value
Fireside pressure drop	Inch W.C. [mbar]	0.802 [2.0]
Required vent connection pressure	Inch W.C. [mbar]	+0.1 - +0.2 [.025 - .498]
Minimum flow rate	GPM [LPM]	none
Maximum flow rate	GPM [LPM]	none
Maximum supply water temperature	°F [°C]	210 [98.8]
Minimum return water temperature	°F [°C]	none

Burner Data		
	Unit	Value
Allowable fuels	-	Natural gas, LP, Ultra low sulfur diesel (ASTM D396 No. 2), Fuel oil no. 2 (with operating requirements)
Motor voltages, gas/oil pressure and modes of operation will vary based upon final burner selection - see burner specification sheet for additional details	-	-

Buderus SB625WS/160  
Stainless Steel Condensing Boiler



Approval Data	
<b>Approval description</b>	<b>Approval number</b>
Massachusetts Plumbing Board	Approved
CRN #	W0846.2C

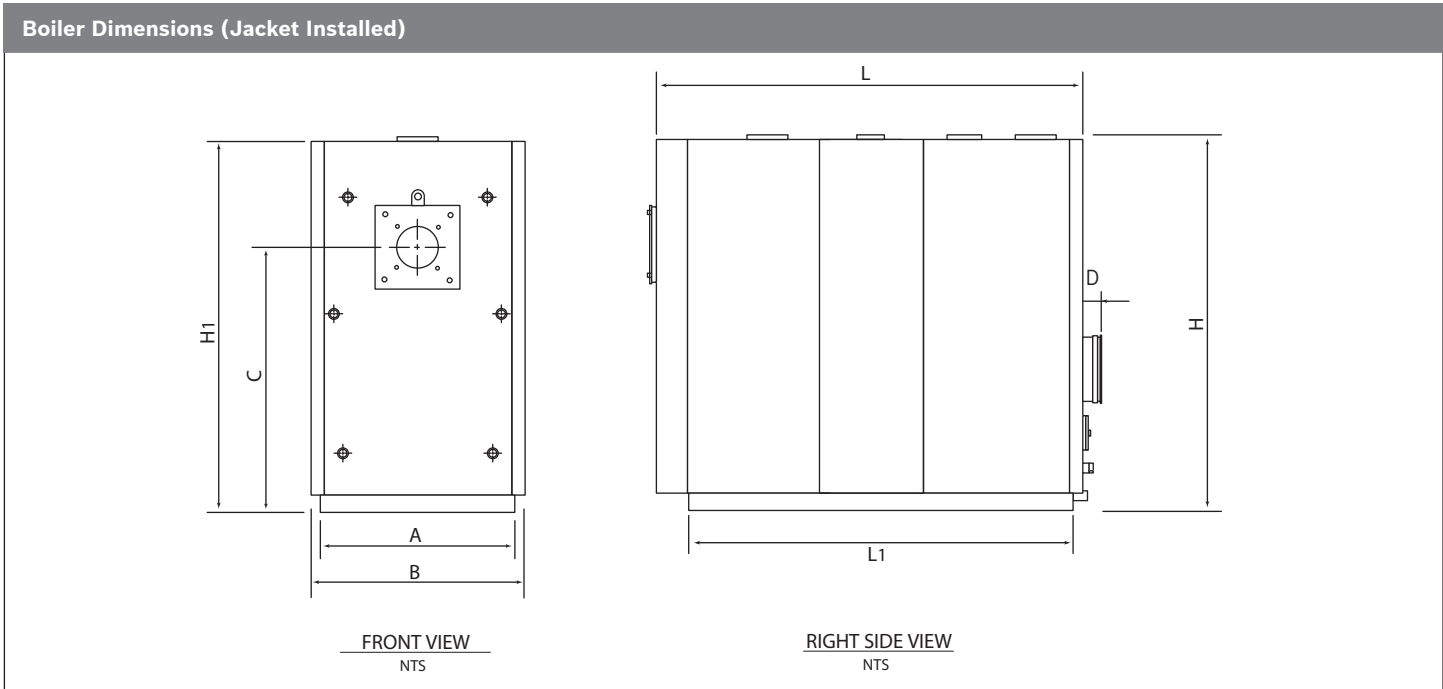

Boiler Dimensions Data			
Item	Description	Unit	Value
A	Base width	Inch [mm]	27 <sup>3</sup> / <sub>16</sub> [690]
B	Overall width	Inch [mm]	29 <sup>1</sup> / <sub>8</sub> [740]
C	Height of burner plate (centerline)	Inch [mm]	36 <sup>7</sup> / <sub>16</sub> [925]
D	Flue depth	Inch [mm]	2 <sup>3</sup> / <sub>4</sub> [70]
H	Height of water fittings	Inch [mm]	52 <sup>3</sup> / <sub>4</sub> [1340]
H1	Boiler height	Inch [mm]	52 <sup>3</sup> / <sub>16</sub> [1325]
L	Length	Inch [mm]	57 <sup>5</sup> / <sub>16</sub> [1455]
L1	Base Length	Inch [mm]	51 [1295]

\* All dimensions above are within +/- 1/4".

# Buderus SB625WS/160 Stainless Steel Condensing Boiler



# BOSCH

## Boiler Block Dimensions and Connections (Jacket Removed)

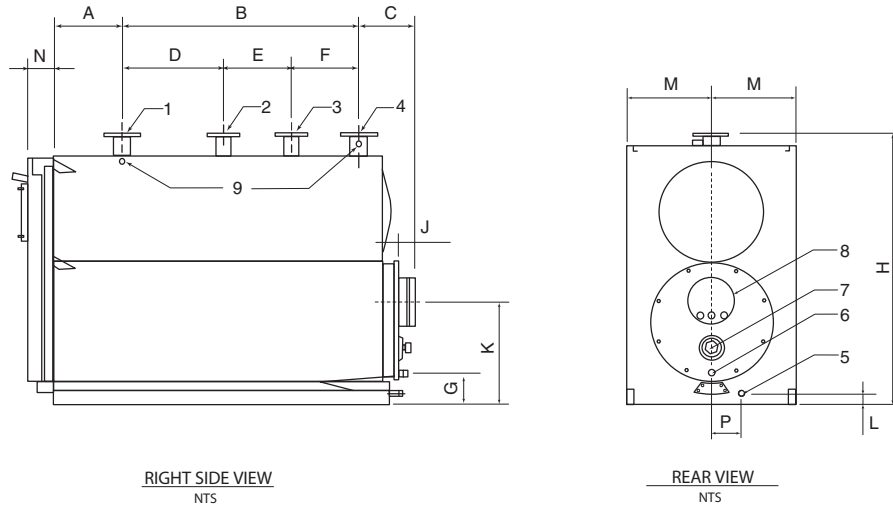

## Boiler Block Dimensions and Connections Data

Item	Description	Unit	Value
A	Distance from burner head to heating supply outlet	Inch [mm]	11 7/8 [302]
B	Distance between heating supply outlet and return 1	Inch [mm]	34 7/8 [885]
C	Distance between heating return 1 and flue gas outlet	Inch [mm]	10 5/8 [270]
D	Distance between heating supply outlet and safety device fitting	Inch [mm]	15 3/4 [400]
E	Distance between heating return 2 and safety device fitting	Inch [mm]	11 1/4 [285]
F	Distance between heating return 1 and 2	Inch [mm]	7 7/8 [200]
G	Height of condensate drain	Inch [mm]	6 5/16 [160]
H	Height of water fittings	Inch [mm]	52 3/4 [1340]
J	Flue depth	Inch [mm]	2 3/4 [70]
K	Height of flue gas outlet (centerline)	Inch [mm]	20 1/4 [515]
L	Height of boiler drain fitting	Inch [mm]	2 3/8 [60]
M	Boiler centerline	Inch [mm]	13 9/16 [345]
N	Distance from burner head to door	Inch [mm]	4 5/16 [110]
P	Distance from Boiler drain fitting	Inch [mm]	5 3/16 [132]
1	Heating supply	Inch [DN]	2 1/2 [65]
2	Safety device fitting	Inch [DN]	1 1/4 [1.25]
3	Heating return 2 (High Temperature)	Inch [DN]	2 [50]
4	Heating return 1 (Low Temperature)	Inch [DN]	2 1/2 [65]
5	Boiler drain fitting	Inch	1
6	Condensate drain fitting	Inch	1
7	Inspection port	—	—
8	Flue gas outlet	Ø mm	200
9	Instrument bulb/probe sockets	Inch	3 x 1/2

\* All dimensions above are within +/- 1/4".

# Buderus SB625WS/160 Stainless Steel Condensing Boiler



# BOSCH

## Boiler Pressure Drop Chart

Temperature Rise	Unit	Value
20 degree $\Delta T$	Ft. Hd. [mbar]	5.0 [150]
30 degree $\Delta T$	Ft. Hd. [mbar]	3.0 [89.6]
40 degree $\Delta T$	Ft. Hd. [mbar]	1.0 [30]
100 degree $\Delta T$	Ft. Hd. [mbar]	< 1.0 [< 30]

## Boiler Clearances

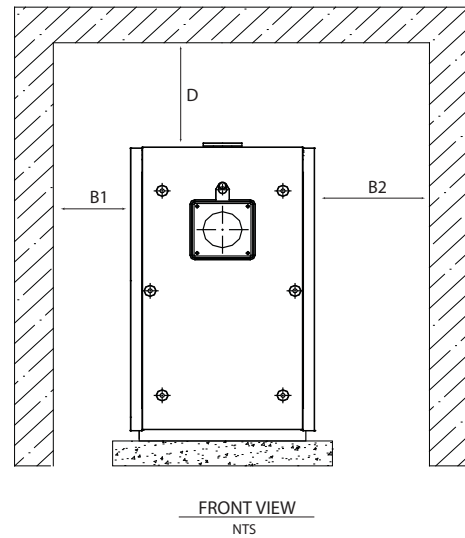
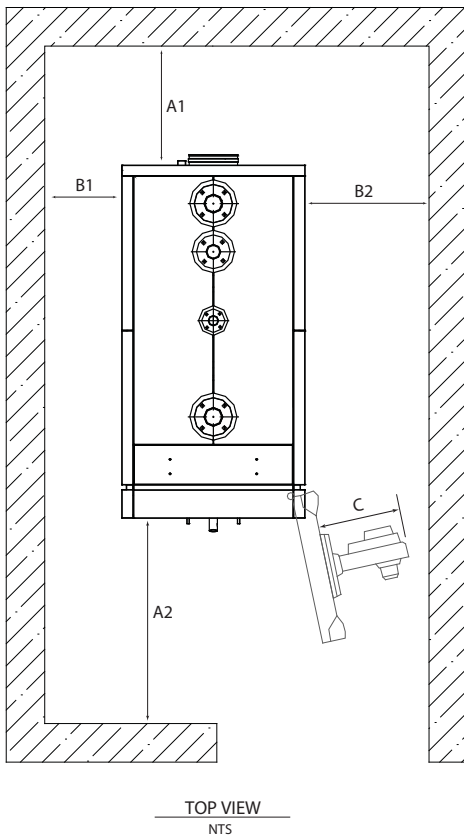

\* NOTE: An installation using the minimum clearance to combustibles will require modifications to the typical installation process. Boiler must be installed on non-combustible floor. Consult factory for additional details.

Description	Unit	Recommended Service Clearance	Minimum Service Clearance	Minimum To Combustible Surface*
Length A1	Inch [mm]	36 [915]	24 [610]	18 [457]
Length A2	Inch [mm]	58 [1626]	64 [1626]	64 [1626]
Length B1	Inch [mm]	36 [915]	18 [457]	6 [152]
Length B2	Inch [mm]	36 [915]	C+4 [C+100]	6 [152]
Length D	Inch [mm]	36 [915]	18 [457]	18 [457]

### DISCLAIMER

Specifications subject to change without notice. All dimensions shown on these engineering submittal sheets are for reference only and should not be used for field installation purposes. Please refer to current product installation manuals for detailed installation instructions and dimensions.